

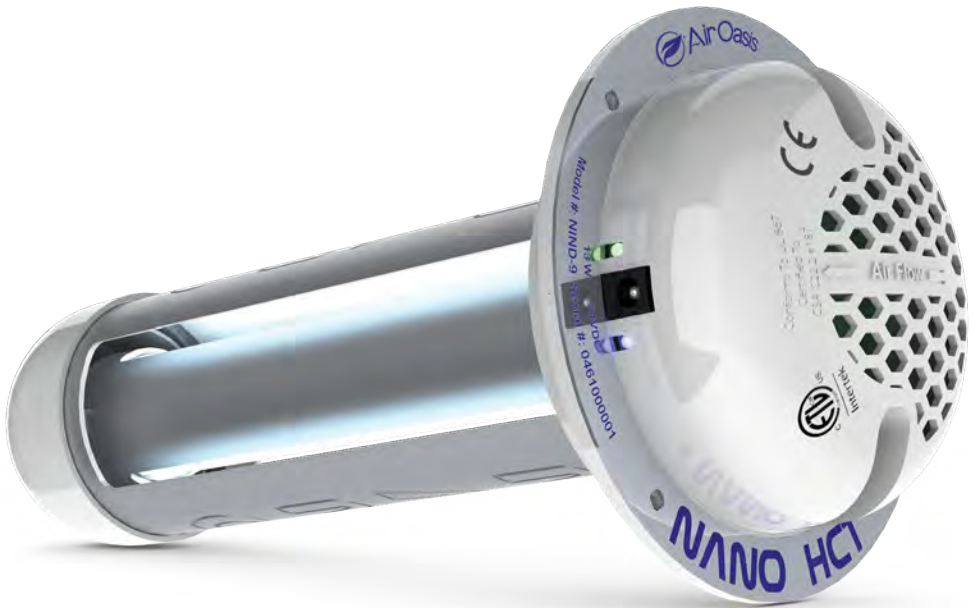

# NANO INDUCT™

Owner's Manual



R2021.02.10

For use with model: NIND9



For safety and to ensure proper use carefully read the contents of this manual before operating or installing the unit.

# Thank You for Choosing The nano Induct Sanifier®!

---

Congratulations, you own the most advanced induct air purifier available! Before operating the nano Induct™ please read this manual in its entirety. Doing so will give you important information to keep you safe from harm and ensure you get the most benefits from your Sanifier®. For additional information please contact us:

mail: Air Oasis, LLC  
Attn: Customer Service  
3401 Airway Blvd.  
Amarillo, TX 79118

web: [www.airoasis.com](http://www.airoasis.com)  
e-mail: [feedback@airoasis.com](mailto:feedback@airoasis.com)  
phone: 1-800-936-1764

## Table of Contents

---

Important Safety Instructions .....	1
Status Indicator Lights .....	2
Power Adaptor, Placement and Installation .....	3 - 6
Initial Startup .....	7
Maintenance .....	8
Limited Warranty .....	9
Trouble Shooting Guide.....	back cover
Product Specifications.....	back cover

# Important Safety Instructions

When operating any electrical appliance, basic precautions should always be followed for safety.

## RISK OF FIRE, ELECTRIC SHOCK, OR INJURY

- Carefully read the entire contents of this manual.
- Do not use outdoors, in moist areas or on wet surfaces.
- Do not use the unit in areas of extreme heat or in the presence of flammable gas.
- Do not allow any foreign objects to enter the ballast cooling vents.
- Do not attempt to service or repair the unit yourself. Any attempt to repair the unit yourself could cause serious injury and will void the warranty.
- Do not handle the plug or appliance with wet hands.
- Do not pull on power cord to unplug. To unplug grasp the plug, not the cord.
- Do not use with damaged power cord or plug. If appliance is not working properly, has been dropped, damaged, left outdoors, or dropped into water, call a customer service representative at 1-800-936-1764.

Cooling Vents





**WARNING: RISK OF ELECTRICAL SHOCK. CAN CAUSE INJURY OR DEATH. UNPLUG OR DISCONNECT UNIT FROM POWER SUPPLY BEFORE SERVICING.**

 Store and transport -4° F ~ 180° F, humidity 10% ~ 90% (Non Condensing).

 Do not operate unit in ambient temperatures above 150° F.

 KEEP OUT OF REACH OF CHILDREN

 Only use the power adapters included with the purification system.

 **WARNING: UV LIGHT HAZARD.**  
Harmful to skin and eyes. Can cause temporary or permanent loss of vision. Never look at the lamp while illuminated. To prevent exposure to ultraviolet light, be sure the power is disconnected until installation is completed and before servicing.

<b>WARNING</b> OPTICAL RADIATION EXPOSURE HAZARD	
	DO NOT ATTEMPT TO OPERATE UNIT WITHOUT PROPERLY INSTALLING UNIT FIRST. PERMANENT EYE DAMAGE MAY RESULT.
	

 UV lamps contain Hg (Mercury).

High or long term exposure to Hg can lead to serious health risks. UV lamps should be disposed of according to disposal laws in your area. UV lamps should never be disposed via standard waste receptacles. They often break when thrown into a dumpster, trash can or compactor, or when they end up in a landfill or incinerator. Learn more about proper disposal methods and find disposal centers at [www.earth911.org](http://www.earth911.org).

 Never touch UV lamp with bare hands. Oils from your skin can create hot spots causing UV lamp to break when illuminated.

 Never remove the outer housing of any components.

# Status Indicator Lights

The nano Induct contains a smart ballast which provides a warm-up period then checks for correct operation and continuously watches for any fault condition. Should a fault be detected the Red LED will start flashing. The number of repeating blinks will indicate the type of fault.

This ballast continuously monitors the temperature and frequency of the power converter circuit. Almost all faults will result in either an over temperature condition or the power converter not operating at the nominal design frequency. If a fault condition is detected the Red LED will flash.

## “Lamp Status” Indicator

### Green

Unit has power, ballast and UVC lamp are operating correctly.

### Red

The Red LED indicates a fault condition. Details of the fault can be detected by counting the number of repeating flashes. 2 flashes is an over temperature condition, 3 flashes is a UVC lamp fault or open circuit, more than 3 flashes is an internal circuit fault.

## “Lamp Replacement” Indicator

### Blue Solid

The Blue LED is on during normal operation. The UVC lamp is within its two year life span. No action is needed.

### Blue Flashing

The UVC lamp is outside its two year life span, output has decreased and it should be replaced.

## No Lights Illuminated

The unit is not properly connected to the power supply.

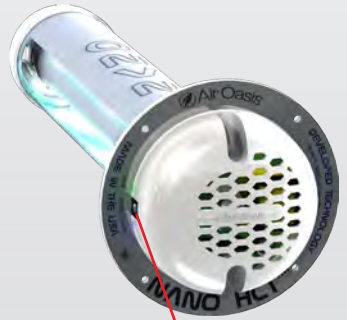

Status Indicator Lights



# Power Adapter

---

The nano Induct is powered using a 26 VDC power adapter with a rated input voltage of 100 - 240 VAC. The adapter connects to a 110 or 230 VAC 3 amp power cord. For your safety and to ensure proper function of your nano Induct we recommend that ONLY the power adapter included with the original purchase be used.

## Placement and Installation

---

### Placement Suggestions

The nano Induct units are designed to be installed within the duct of an HVAC system. We recommend they be mounted on the supply side plenum.

- We recommend you leave the Rotational UV Shields in the closed position. The shields should only be opened for specialized applications.
- The nano Induct should not be installed in extremely close proximity to heat strips or other heat sources. Polymers can begin to soften at approximately 200°F.
- Multiple units may be needed in larger air handlers or areas of higher contamination.

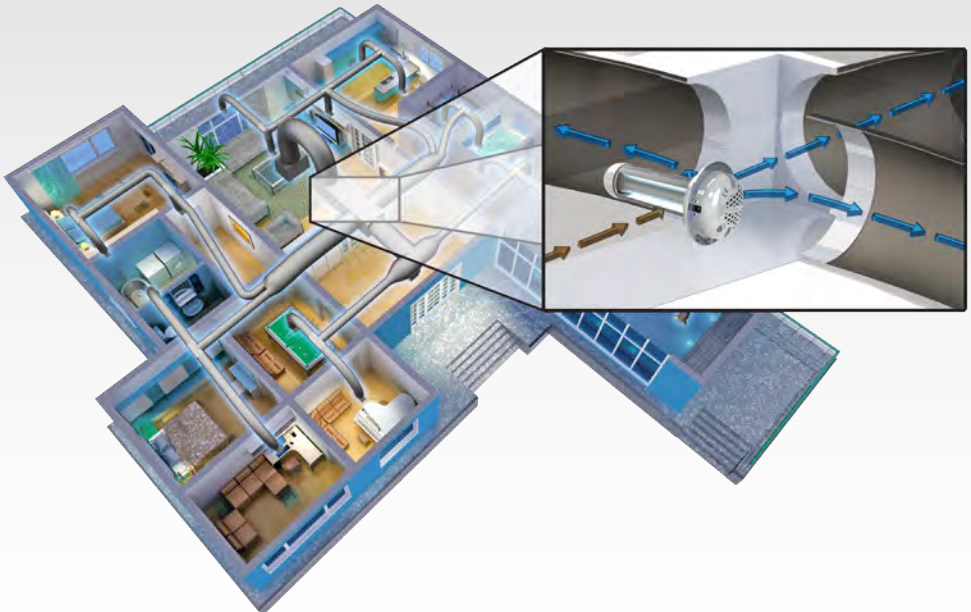

## Preparing to Install

The nano Induct was designed to be simple and effective. Remove the unit, power adapter, power cord, and mounting hardware from the box.

## Installation Instructions

Installation and servicing of air-conditioning equipment can be hazardous due to system pressure and electrical components. Only trained and qualified service personnel should install, repair, or service air-conditioning equipment. Air Oasis and its affiliates are not responsible for any damage to the HVAC system, nano Induct or injury to yourself or others if you elect to install the device without utilizing qualified technicians.

Use the suggestions on page 3 to determine the optimal mounting location(s).

To complete the installation process we recommend the following tools:

- Power Drill
- 3 3/4" inch hole saw
- 1/4 inch hex head screw driver

1. Cut a 3 3/4" hole in the duct where the device will be mounted. Center the hole ensuring there will be at least a 5" diameter of duct around the outside of the hole. If mounting on a horizontal fiberglass duct board we recommend inserting the nano Induct from the top side of the plenum to allow gravity to help secure the unit in place.

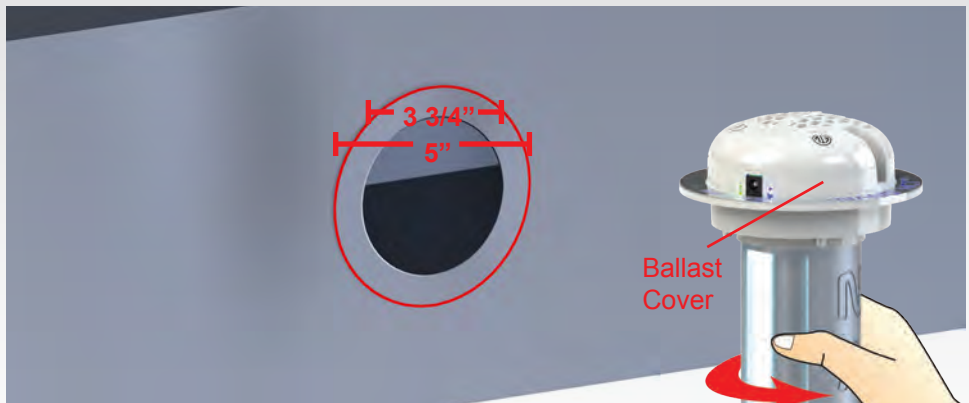

2. Should you choose to open the shields, place one hand on the Distal Cap and the other on the Outer UV Shield. Rotate the Distal Cap clockwise while rotating the Shield counter clockwise until the desired position is reached. Rotation will require firm pressure.

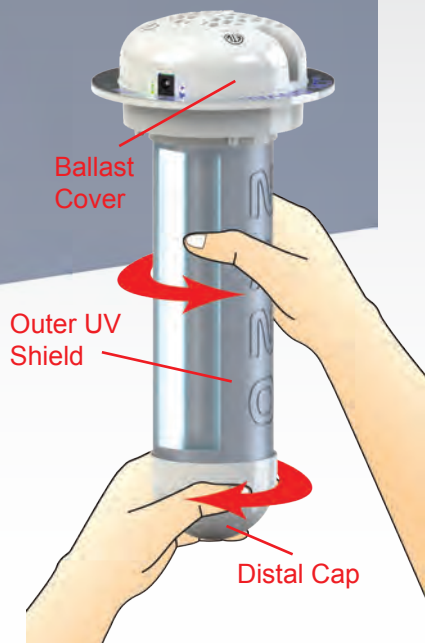

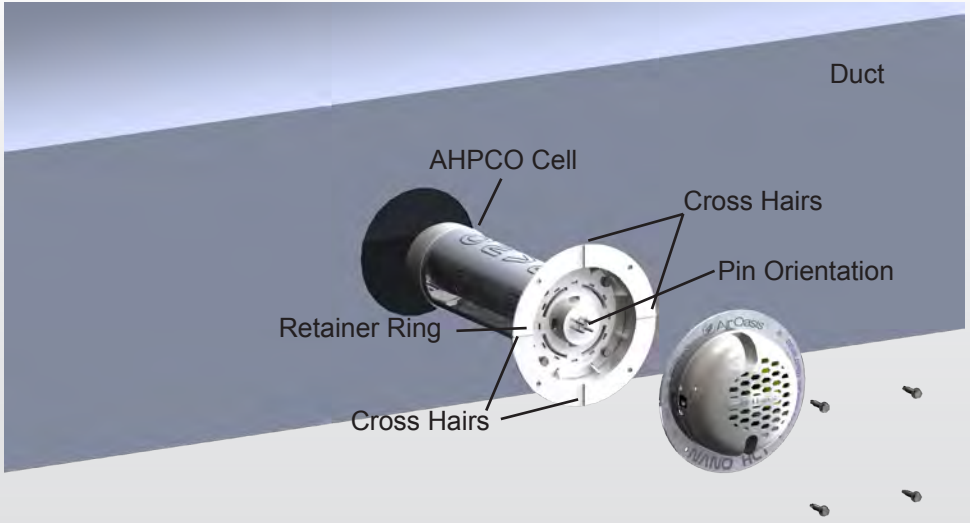

3. Clean a one inch area around the hole where the NIND will be mounted. Remove the wax paper from the gasket. Insert the NIND into the 3 3/4" hole, aligning the cross hairs parallel to the duct. Press firmly on the Retainer Ring to adhere the gasket to the duct.

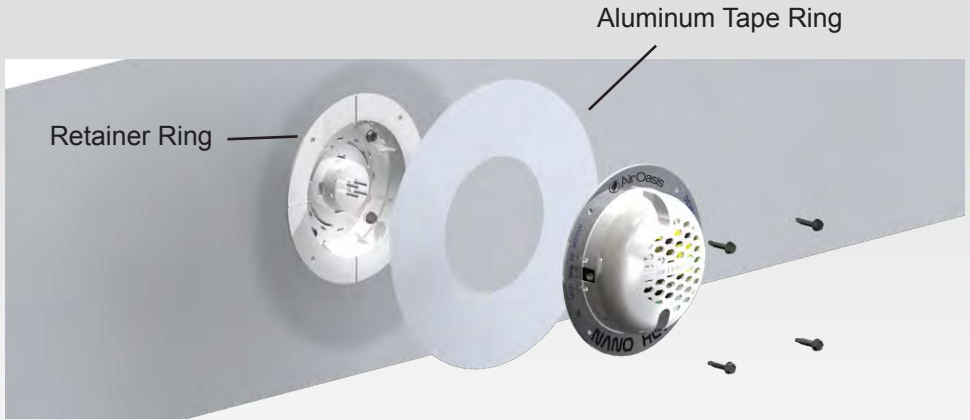

4. If installing on fiberglass duct board place aluminum tape ring over the Retainer Ring to help secure the unit.

5. Firmly press the Ballast Assembly onto the four pins protruding from the AHPCO Cell. The Ballast Assembly should be orientated with the "air flow" label running parallel with the length of the duct to ensure the four pins are in line with the Four Pin Connector. Optional mounting configurations, such as opening the UV shields, may vary the orientation of the "air flow" label. It's only intended to serve as a general guideline.

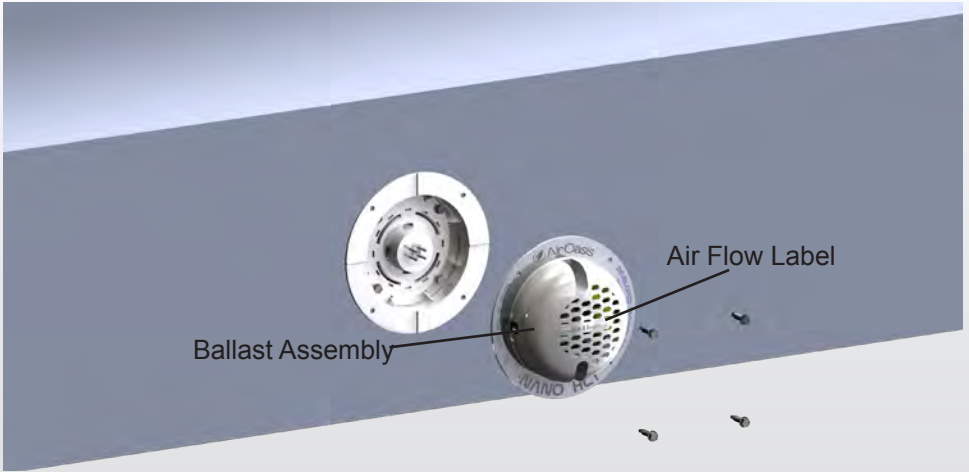

6. Secure the NIND with four self tapping 3/4" screws being careful not to over-tighten.
7. Secure the power adapter with included self tapping 1/2" screws.
8. Adhere the two included warning labels in close proximity to the NIND device.

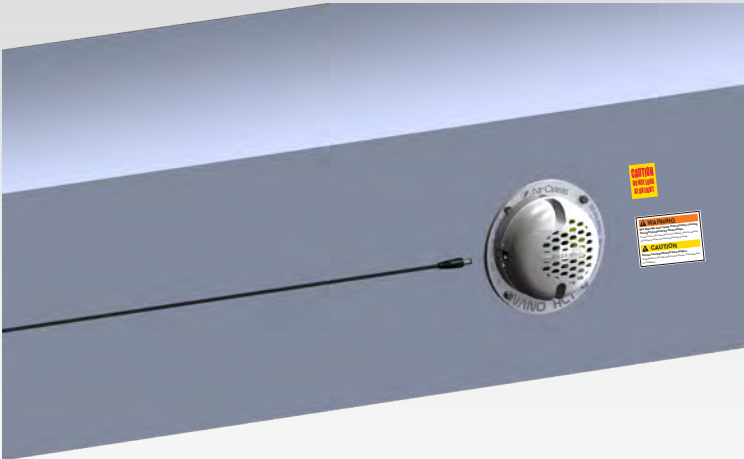



# Initial Start Up

Plug the included power adapter into the nano In duct. Connect the power adapter to a 110 or 240 VAC electrical outlet. The unit will start, with the green and blue lights illuminating. It's designed for continuous operation. For maximum effectiveness, operate the unit 24 hours a day, 7 days a week.

## Optional 24 VAC Internal HVAC Power Source Wiring

When wiring direct to 24V we strongly recommend installing a separate 40 VA transformer to ensure optimal performance and reduce the risk of overloading the circuit.

## SAFETY CONSIDERATIONS

Read and follow manufacturer instructions carefully. Follow all local electrical codes during installation. All wiring, must conform to local and national electrical codes. Improper wiring, or installation may damage unit and/or cause serious injury.

## WARNING

Before beginning any modification, be certain that the main line electrical disconnect switch is in the OFF position. Electric shock could result. Tag disconnect switch with suitable warning labels.

Installation and servicing of air-conditioning equipment can be hazardous due to system pressure and electrical components. Only trained and qualified service personnel should install, repair, or service air-conditioning equipment. Air Oasis and its affiliates are not responsible for any damage to the HVAC system, NIND or injury to yourself or others if you elect to install the NIND without utilizing qualified technicians.

## WARNING

The NIND is designed to operate at 24 VAC. Damage or physical injury could result if wired to higher voltages.

1. Wire electrical power plug to the 24 VAC internal power source. Before wiring the NIND to the power source, check with a voltmeter that the source does not exceed 30 VAC.
2. Insert the power plug into the port on the NIND. If it is necessary to pass the cord through a hole in the wall of the air handler or through an access door, a rubber grommet should be inserted in the hole or electrical tape should be wrapped around the cord at the point of entry for protection.

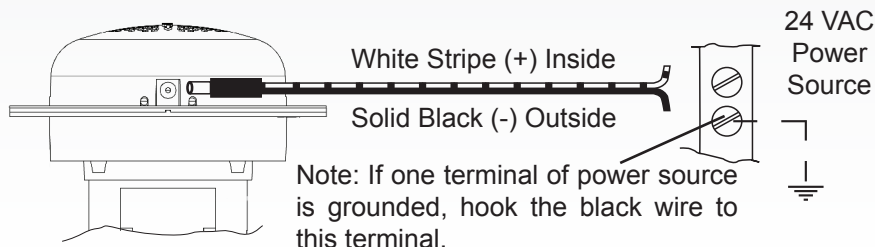

# Maintenance

## AHPCO® Cell Replacement Process

The entire Cell should be replaced every two years. Failure to replace the Cell will decrease the effectiveness of the unit. After two years of use the blue Lamp Replacement light will begin to blink as a reminder that it's time to replace the AHPCO® Cell.

Note: UV lamps contain Hg (Mercury) and should be disposed of according to disposal laws. Find disposal centers at [www.earth911.org](http://www.earth911.org).

We recommend contacting a licensed HVAC professional to perform the replacement process.

1. Unplug the NIND from its power source.
2. Remove the four screws securing the Ballast Assembly and pull the Ballast Assembly away from the Retainer Ring until the four pins have completely disconnected from the Ballast Assembly.
3. Remove the four screws securing the AHPCO® Cell and pull the AHPCO® Cell out from the Retainer Ring. Properly dispose of the AHPCO® Cell.
4. Insert the new AHPCO® Cell and secure with four 1/4" hex head screws. Do not overtighten the screws.
5. Using a small cylindrical object, such as a pen, press and hold the Lamp Reset Button for 3 seconds while connected to power. This will reset the Lamp Replacement Indicator. The Lamp Reset Button is located on the bottom of the Ballast Assembly.
6. Press the Ballast Assembly onto the four pins protruding from the AHPCO® Cell. The Ballast Assembly should be orientated with the "air flow" label running parallel with the length of the duct to ensure the four pins are in line with the Four Pin Connector. Optional mounting configurations, such as opening the UV shields, may vary the orientation of the "air flow" label. It's only intended to serve as a general guideline.
7. Using a 1/4" hex head screw driver, secure the NIND with four self tapping 3/4" screws being careful not to overtighten stripping the screw holes.

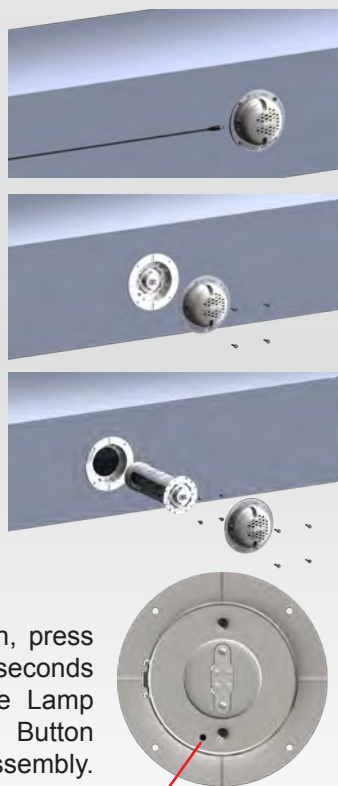



To view our warranty information, terms and conditions and privacy policy, go to:

**<https://www.airoasis.com/policies/#warranty-policy>**

## Troubleshooting Guide

Problem/Question	Solution/Answer
What if my NIND won't turn on? The indicator lights are not illuminated.	Check to make sure the power adapter is firmly plugged into the electrical outlet and the NIND.
The Lamp Status indicator light has turned from green to red.	Reset the unit by unplugging it for the power source. Check to make sure the four pins on the AHPCO® Cell are fully inserted into the Ballast Assembly. Reconnect the power. If the indicator light is still red contact Air Oasis or an authorized dealer.
The Lamp Replacement indicator light is blinking.	This is an indication that it has been two years since the AHPCO® Cell has been replaced. Contact an Air Oasis authorized dealer to purchase a new AHPCO® Cell.
<p>If the above does not repair the symptom please contact an Air Oasis Customer Service Representative:</p> <p>Phone: 1-800-936-1764                      E-mail: <a href="mailto:feedback@airoasis.com">feedback@airoasis.com</a> Web: <a href="http://www.airoasis.com">www.airoasis.com</a></p> <p>Mail: Air Oasis                      Customer Service                      3401 Airway Blvd..                      Amarillo, TX 79118</p>	

## nano Induct Specifications

Operational	NIND9 Coverage Warranty	Up to 4 to 6 tons (1600 - 2400 CFM) Two year limited warranty
Replacements	NINDAHPCO 9	Replace every two years.
Electrical	NIND9 Usage	24 VAC/26VDC, 0.50 Amps, 13 Watts
Mechanical	NIND9 Dimensions Weight of Unit Shipping Weight	4" L x 4" W x 10.7" H 1 lbs 5 lbs

